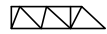
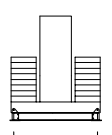

Torre/Reazioni – Masts/Reactions – Mat/Réactions – Maste/Eckdrücke – Mästil/Reacciones – Tramo/Reacções

SF1100

 11.6 m \rightarrow 40 m

Torre/Masts/Mat/Maste/Mästil/Tramo						
 2.8x2.8 m R2 CAF	H[m]	2f/2f B0058	2f/1f BA058	1f/1f ST058	2f/1f BA116	1f/1f ST116
	29	4	1			
	23.2	3	1			
	17.4	2	1			
	11.6				1	
	5.8					

H=0–12 m	
R1	19 t
R2	18 t
R3	15 t
M	26 tm

H=13–23 m	
R1	21 t
R2	20 t
R3	16 t
M	32 tm

H=24–29 m	
R1	
R2	23 t
R3	17 t
M	40 tm

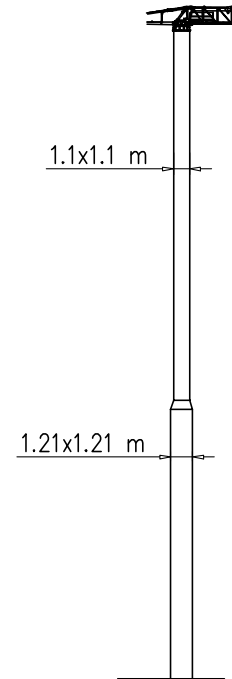

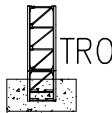
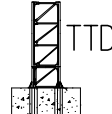
Torre/Masts/Mat/Maste/Mästil/Tramo						
 TRO R3 M  TTD	H[m]	2f/2f B0058	2f/1f BA058	1f/1f ST058	2f/1f BA116	1f/1f ST116
	29	4	1			
	23.2	3	1			
	17.4	2	1			
	11.6				1	
5.8						

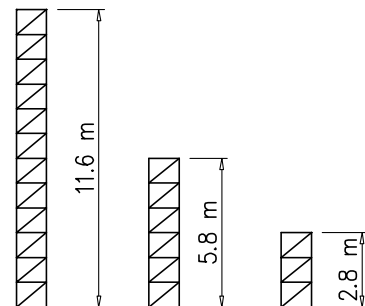

Peso zavorra – Ballast weight – Poids du lest – Ballastgewicht – Peso de lastre

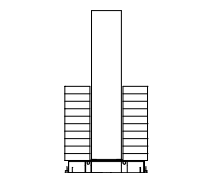



H	Tot.
0–12 m	22000 kg
13–23 m	26400 kg
24–29 m	30800 kg

Torre/Reazioni – Masts/Reactions – Mat/Réactions – Maste/Eckdrücke – Mästil/Reacciones – Tramo/Reacções

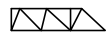
SH1210

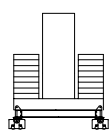
 11.6 m \rightarrow 40 m

Torre/Masts/Mat/Maste/Mästil/Tramo						
 3.2x3.2 m R1 CATR  CATC 	H[m]	2f/2f ST030	2f/2f ST060	2f/2f ST120		
	36	6				
	30	5				
	24	4				
	18	3				
	12	2				

H=0–18 m	
R1	18 t
R2	17 t
R3	17 t
M	28 tm

H=19–30 m	
R1	21 t
R2	20 t
R3	19 t
M	40 tm

H=31–36 m	
R1	26 t
R2	25 t
R3	20 t
M	48 tm

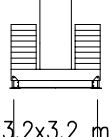
Torre/Masts/Mat/Maste/Mästil/Tramo						
 3.2x3.2 m R2 CAF	H[m]	2f/2f ST030	2f/2f ST060	2f/2f ST120		
	42	7				
	36	6				
	30	5				
	24	4				
18	3					

H=37–42 m	
R1	
R2	69 t
R3	40 t
M	185 tm

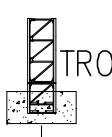
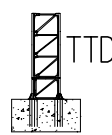
Torre/Masts/Mat/Maste/Mästil/Tramo						
 TRO R3 M  TTD	H[m]	2f/2f ST030	2f/2f ST060	2f/2f ST120		
	42	7				
	36	6				
	30	5				
	24	4				
18	3					

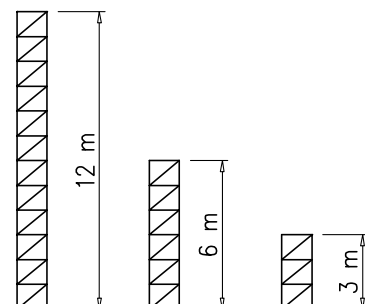
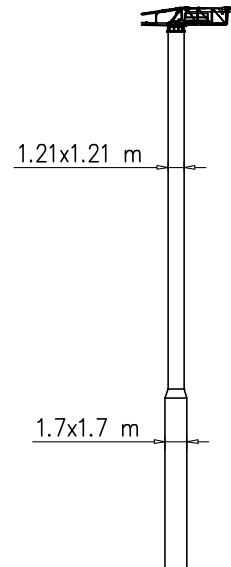

Peso zavorra – Ballast weight – Poids du lest – Ballastgewicht – Peso de lastre

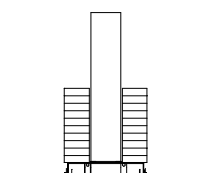

H	Tot.
0–18 m	18000 kg
19–30 m	24000 kg
31–36 m	36000 kg
37–42 m	60000 kg





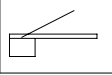
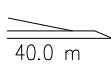
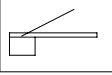
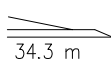
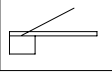
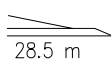
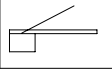
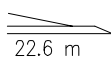
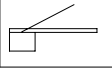
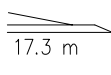
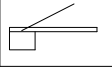
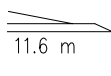



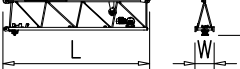
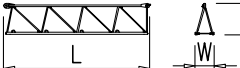
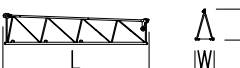
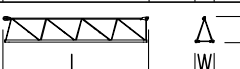
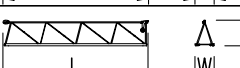
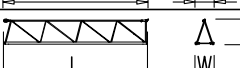
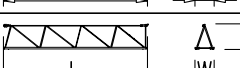
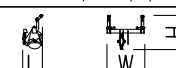
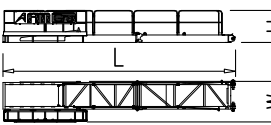
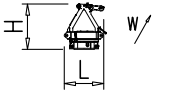
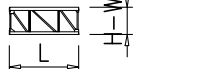

Curve di carico – Courbes de charges – Load diagrams – LastKurven – Curvas de cargas

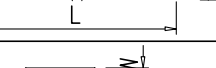
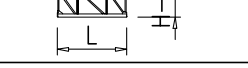
Pmax 2400 kg

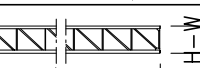

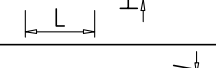
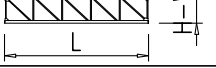
	7680 kg	 40.0 m	2	18.5	22.6	28.5	34.3	40.0	m
			2400	2400	1920	1500	1200	1000	kg
	6600 kg	 34.3 m	2	20.0	22.6	28.5	34.3	m	
			2400	2400	2180	1680	1350	kg	
	6030 kg	 28.5 m	2		22.6	28.5		m	
			2400		2400	1900		kg	
	4950 kg	 22.6 m	2		22.6			m	
			2400		2400			kg	
	4380 kg	 17.3 m	2		17.3			m	
			2400		2400			kg	
	3300 kg	 11.6 m	2		11.6			m	
			2400		2400			kg	

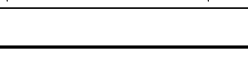
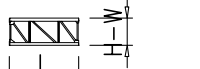
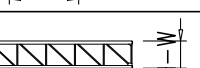

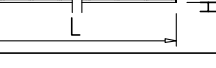
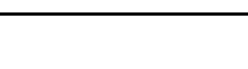
PESI E INGOMBRI – PACKING LIST – LISTE DE COLISAGE – GEWICHT UND ABMESSUNGEN

Denominazione Description	Disegno Draw	Pezzi Pieces	Dimensioni-Dimensions (mm)			Peso-Weight (kg)		
			L	W	H	Unit	Total	
Elemento di braccio Jib element Elément de èche Elemento de flecha	n°7 	1	5910	800	1500	900	–	
	n°6 	1	5910	760	1270	590	–	
	n°5 	1	5890	760	1260	460	–	
	n°4 	1	5870	760	1050	390	–	
	n°3 	1	5850	760	1040	285	–	
	n°2 	1	5830	760	1020	205	–	
	n°1 	1	5820	760	1020	180	–	
	Punta braccio 	1	410	760	690	45	–	
Contorbraccio completo Complete counterjib Contreflèche complète Contraflecha completa		1	9400	1650	1310	2250	–	
Gruppo girevole Slewing group Table tournante Grupo giratorio		SF1100	1	1600	1350	1830	2050	–
		SH1210	1	1600	1350	1830	2200	–
Elemento di torre Mast element Elément de mature Elemento de torre	ST028 	SF1100	–	2800	1100	1100	550	–
	ST030 	SH1210	–	3000	1210	1210	840	–
	ST058 	SF1100	–	5800	1100	1100	1010	–
	ST060 	SH1210	–	6000	1210	1210	1490	–
	ST116 	SF1100	–	11600	1100	1100	1900	–
	ST120 	SH1210	–	12000	1210	1210	3000	–
	B0028 	SF1100	–	2800	1100	1100	600	–
	B0030 	SH1210	–	3000	1210	1210	900	–
	B0058 	SF1100	–	5800	1100	1100	1260	–
	B0060 	SH1210	–	6000	1210	1210	2120	–
	B0116 	SF1100	–	11600	1100	1100	2370	–
	B0120 	SH1210	–	12000	1210	1210	3500	–
	BA028 	SF1100	–	2800	1100	1100	555	–
	BA030 	SH1210	–	3000	1210	1210	870	–
	BA058 	SF1100	–	5800	1100	1100	1020	–
	BA060 	SH1210	–	–	–	–	–	–
	BA116 	SF1100	–	11600	1100	1100	2030	–
	BA120	SH1210	–	–	–	–	–	–

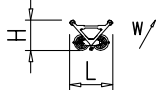
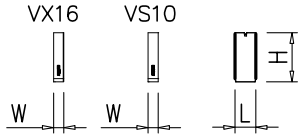
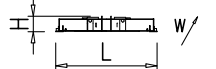
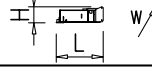
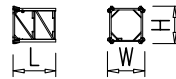
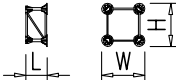
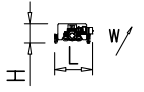
PESI E INGOMBRI – PACKING LIST – LISTE DE COLISAGE – GEWICHT UND ABMESSUNGEN

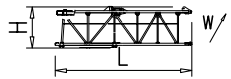
Denominazione Description	Disegno Draw	Pezzi Pieces	Dimensioni-Dimensions (mm)			Peso-Weight (kg)		
			L	W	H	Unit	Total	
Carrello Trolley Chariot Carretilla		1	880	980	650	75	–	
Blocchi contrappeso Counterweight block Contre-poids Bloques de contrapeso		VS10	1	850	420	1300	1080	1080
		VX16	4	850	420	2000	1650	6600
Carro di base Base carriage Chassis de base Cruceta de base		2.8x2.8	1	4100	520	660	1050	1050
		3.2x3.2	1	4670	520	660	1160	1160
		2.8x2.8	2	1900	340	660	480	960
		3.2x3.2	2	2180	340	660	550	1100
Elemento a perdere Disposable frame Chassis a perdre Bastidor desechable		SF1100	1	2315	1100	1100	410	–
		SH1210	1	1990	1210	1210	540	–
Elemento recuperabile Recoverable frame Chassis récupérable Bastidor recuperable		SF1100	1	440	1600	1600	630	–
		SH1210	1	440	1700	1700	660	–
Bogie di traslazione Driven bogie Boggie motorisèe Balancin de traslaciòn		4	1160	700	600	700	2800	
Blocco zavorra di base Base ballast block Lest de base Bloque de lastre		2.8x2.8	–	3200	1000	300	2200	–
		3.2x3.2	–	3600	1150	300	3000	–
Corsoio di montaggio Climbing cage Cage de montage Jaula de montaje		1	8300	1600	1500	3000	–	

Montaggio – Montage – Erection – Montage – Montaje – Montagem

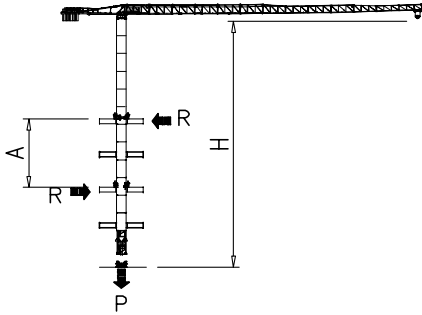

SH1210	H (m)	A (m)	R (t)	P (t)
	30.0	6	25.75	33.0
		7	22.96	
Apertura passaggio gru Opening for crane passing		8	20.88	
		9	19.25	

* SOPRALZO IDRAULICO – TELESOPABLE – EXTERNAL CLIMBING – KLETTERKRANE

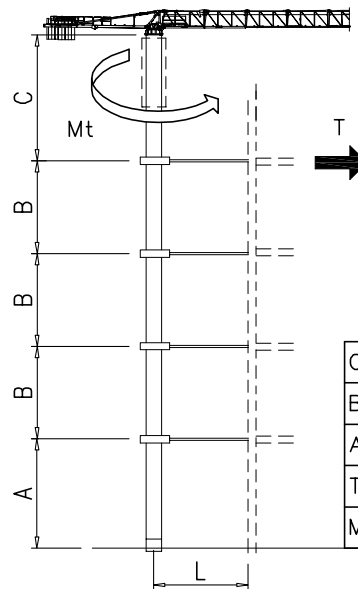
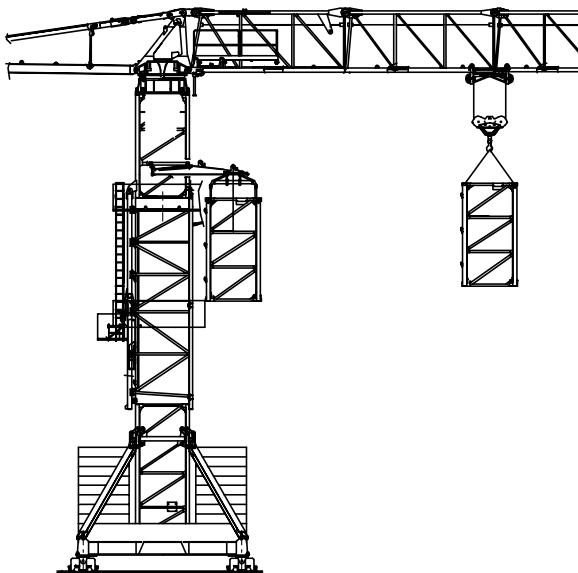

	SH1210	SK1700
C	27.0 m	27.3 m
B	17.0 m	15.6 m
A	32.0 m	39.5 m
T	19 t	23.4 t
MT	23 t xm	26 t xm



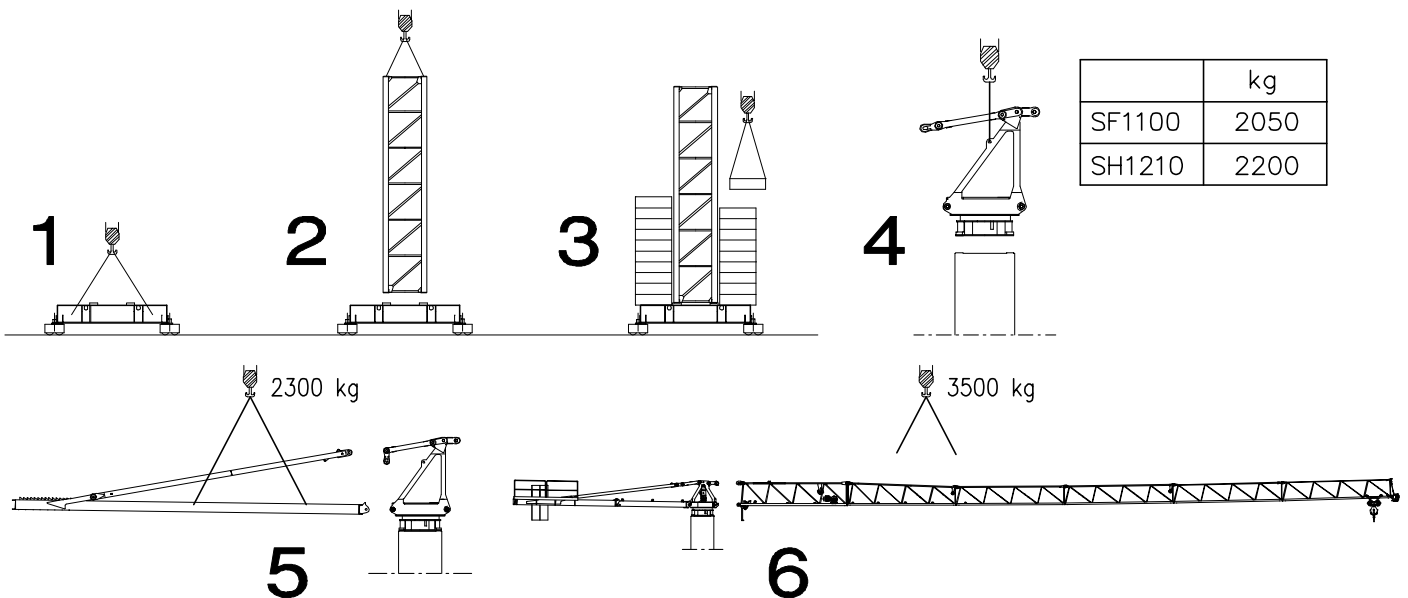

Montaggio – Montage – Erection – Montage – Montaje – Montagem

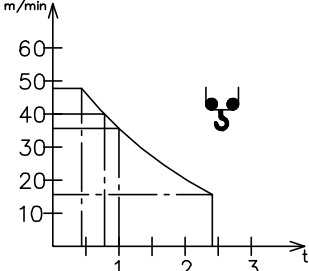
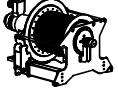

	kg
SF1100	2050
SH1210	2200

Meccanismi – Mechanisms – Mécanismes – Antriebe – Mecanismos

Sollevamento M07.47 Hoisting Levage Heben Elevaciòn Elevaçao							
	m/min	3	16	36	40	47	M07.47
	t	2.4	2.4	1	0.8	0.4	7.5 kW
							18 kVA
							
							110 m

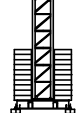
Carrello Trolleying Distribution Katzfahren Distribuciòn Distribuiçao			0 → 70	m/min	1.1 kW	Potenza elettrica necessaria Puissance électrique nécessaire Necessary electric power Anschlusswert – Potencia
Rotazione Slewing Orientation Schwenken Orientaciòn Rotaçao			0 → 0,7	giri/min tr/min rp/min	4 kW	
Traslazione Travelling Translation Kranfahren Traslaciòn Translaçao			0 → 18	m/min	3.7 kW	

Rete elettrica – Réseau – Mains supply – Netzstrom – Red – Rede electrica	400V – 50 Hz
	480V – 60 Hz

AFM Gru FMgru s.r.l.
via Emilia 11–29010 Pontenure PC ITALY
tel. 0523/510446 ric.aut. fax 0523/510365
www.fmgru.it e-mail: info@fmgru.com

FEM 1.001
2000/14/CE



Documento commerciale non contrattuale
Per tutte le informazioni tecniche riferirsi
alle corrispondenti istruzioni

Unverbindliches Vertriebsdokument.
Für technische Informationen, siehe die
entsprechenden Anweisungen.

This commercial document is not legally
binding. For any technical information, please
refer to the corresponding instructions.

Documento commercial no contractual
Para cualquier información técnica,
ver la noticia correspondiente.

Code: 15ICA37T15A0			
Ed.	Data	Rev	Data
1	24.07.06	3	17.03.10