

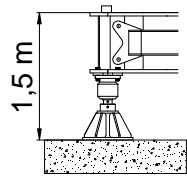

TLS 70 12T

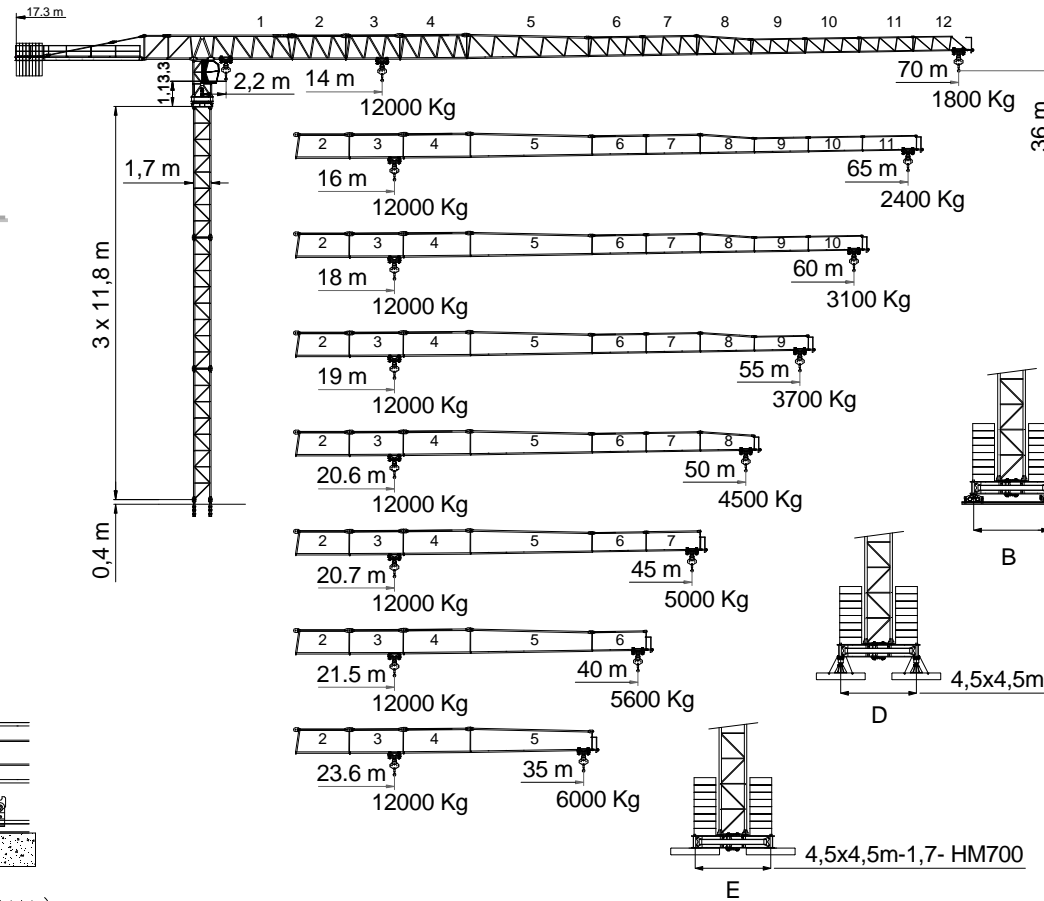

A

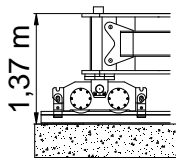

B(OPTIONAL)

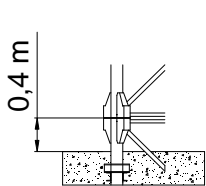

C

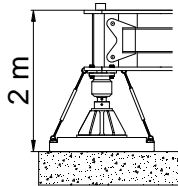

D

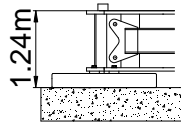

E(4.5x4.5)

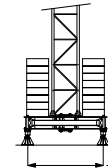

4,5x4,5m-1,7- HM700 hasta H=30m

A

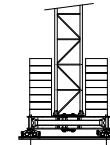

4,5x4,5m-1,7- HM 700

B

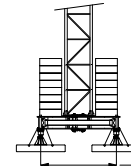

4,5x4,5m-1,7- HM700

D

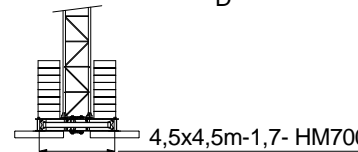

4,5x4,5m-1,7- HM700

E

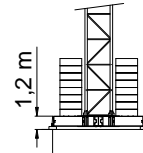

6x6m-2,1- HB900 hasta H=36 m

F











EN 14439-FEM 1005- C25

Viento max. fuerza de servicio 150km/h

Curvas de cargas
Load diagrams
Lastkurven
Courbes de charges
Curve di carico

70 m 	10	15	20	25	26.5	30	35	40	45	50	55	60	65	70	m	
	6000	6000	6000	6000	6000	5207	4343	3700	3203	2808	2486	2219	1993	1800	Kg	
70 m 	5	10	14	15	20	30	35	40	45	50	55	60	65	70	m	
	12000	12000	12000	11304	8100	5007	4143	3500	3003	2608	2286	2019	1793	1600	Kg	
65 m 	10	15	20	25	30	30.4	35	40	45	50	55	60	65	m		
	6000	6000	6000	6000	6000	6000	5109	4368	3795	3340	2969	2660	2400	Kg		
65 m 	10	15	16	20	25	30	35	40	45	50	55	60	65	m		
	12000	12000	12000	9471	7317	5905	4909	4168	3595	3140	2769	2460	2200	Kg		
60 m 	10	15	20	25	30	34.3	35	40	45	50	55	60	m			
	6000	6000	6000	6000	6000	6000	5872	5033	4385	3869	3449	3100	Kg			
60 m 	10	15	18	20	25	30	35	40	45	50	55	60	m			
	12000	12000	12000	10837	8398	6800	5672	4833	4185	3669	3249	2900	Kg			
55 m 	10	15	20	25	30	35	36.3	40	45	50	55	m				
	6000	6000	6000	6000	6000	6000	6000	5381	4693	4146	3700	Kg				
55 m 	10	15	19.3	20	25	30	35	40	45	50	55	m				
	12000	12000	12000	11550	8963	7267	6071	5181	4493	3946	3500	Kg				
50 m 	10	15	20	25	30	35	38.9	40	45	50	m					
	6000	6000	6000	6000	6000	6000	6000	5826	5088	4500	Kg					
50 m 	10	15	20	20.6	25	30	35	40	45	50	m					
	12000	12000	12000	12000	9685	7866	6581	5626	4888	4300	Kg					

Curvas de cargas
Load diagrams
Lastkurven
Courbes de charges
Curve di carico

45 m 	10	15	20	25	30	35	38.4	40	45	m	
	6000	6000	6000	6000	6000	6000	6000	5727	5000	Kg	
	10	15	20	20.7	25	30	35	40	45	m	
	12000	12000	12000	12000	9708	7884	6597	5640	4900	Kg	
40 m 	10	15	20	25	30	35	35.3	40		m	
	6000	6000	6000	6000	6000	6000	6000	5600		Kg	
	10	15	20	21.5	25	30	35	40		m	
	12000	12000	12000	12000	10131	8234	6896	5900		Kg	
35 m 	10	15	20	25	30	35				m	
	6000	6000	6000	6000	6000	6000				Kg	
	10	15	20	23.6	25	30	35			m	
	12000	12000	12000	12000	11269	9176	6600			Kg	

**Mecanismos
Mechanisms
Antriebe
Mécanismes
Meccanismi**

57 Hp (42Kw) - INV-5V
H.B.G 170Mts S/R Ø13

		m/min	0--40	0--46	0--71	0--103	0--20	0--23	0--35	0--51
	440 m	Kg	5000	3500	2000	1250	10000	7000	4000	2500
		Kw	33	33	33	33	33	33	33	33

	m/min	11 / 37 / 75			11 / 37 / 75		
	Kw	3,0			3,0		
	r.p.m	0,3	0,6	0,9	0,3	0,6	0,9
	Nm	2 x 65			2 x 65		
	m/min	12 / 24			12 / 24		
	Kw	4 x 3			4 x 3		

- Elevación / Hoisting / Heben / Levage / Sollevamento
- Distribución / Trolleying / Katzfahren / Distribution / Distribuzione
- Orientación / Slewing / Schwenken / Orientation / Rotazione
- Traslacion / Travelling / Schienenfahren / Translation / Traslazione
- Cable / Rope / Seil / Câble / Fune

 2000/14/CEE 2005/88/CEE	 2006/95 /CEE	400 V 50 Hz	100m 4x35mm ²
--------------------------------	---------------------	----------------	-----------------------------

GENERADOR	POTENCIA INSTALADA
300 kVA	60 KW

 2000/14/CEE 2005/88/CEE	 2006/95 /CEE	380 V 60 Hz	100m 4x35mm ²
--------------------------------	---------------------	----------------	-----------------------------

OPCIONAL

Bloque de contrapeso
Counterweight blocks
Gegengewichtsblöcke
Bloc de contrepoid
Blocco di contrappeso

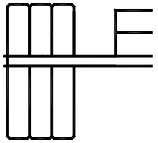
	70 m		
	A	B	C
	8	-	-
	20000 Kg		

FEM 1005-C25 / EN 14439

Mástil / Reacciones
Masts / Reactions
Maste / Eckdrücke
Mat / Réactions
Torre / Reazioni

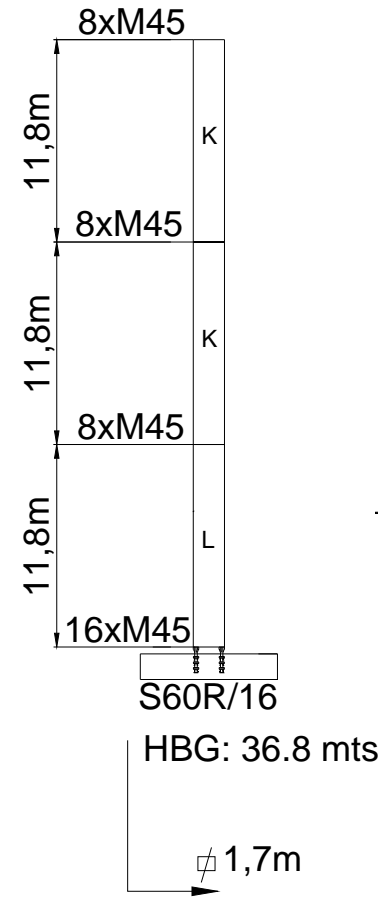
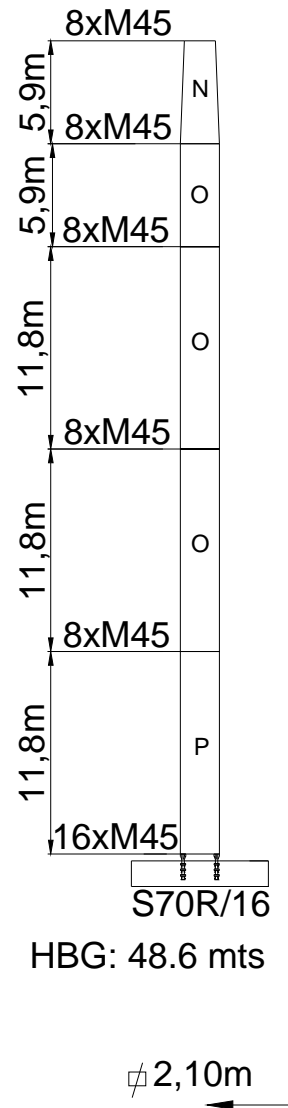

K = S17 8/8
L = S17 16/8
N = S21-S17 8/8
O = S21 8/8
P = S21 16/8

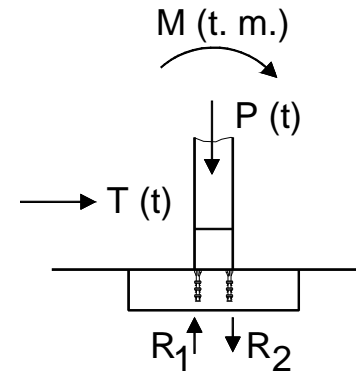

TLS 7012 6-12T



FEM 1005-C25 / EN 14439

Bloque lastre de base
 Base ballast block
 Grundballastblöcke
 Bloc de lest de base
 Blocco di zavorra alla base

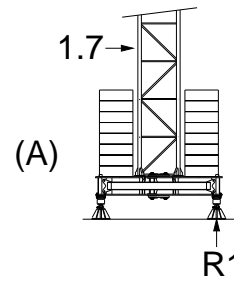

4,5 x 4,5 m-1,7-HM 700	R1 (t)	--
	H (m)	30 m
	Z (t)	--

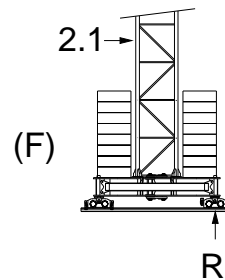

6 x 6 m- 2.1 - HB900	R1 (t)	--
	H (m)	36 m
	Z (t)	--

L(m) W(m) H(m) Peso(Kg)

Pluma tramo primero / Jib heel section / Ausleger-Anlenkstück / Pied de fleche /
Settore articolato di braccio

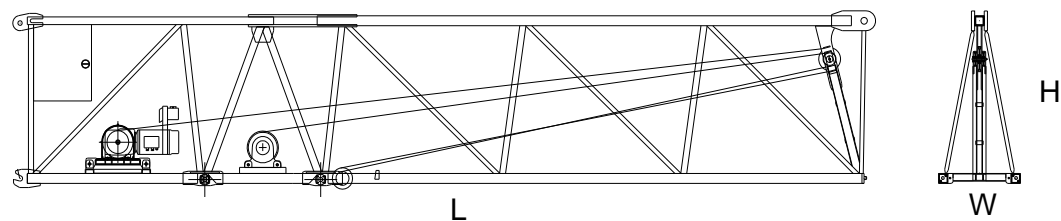



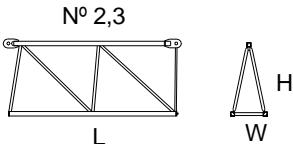
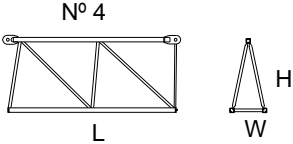
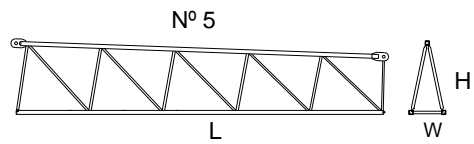
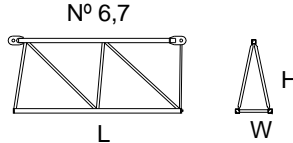
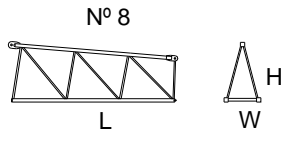
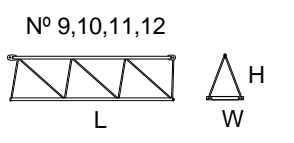
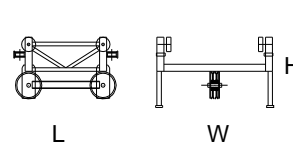
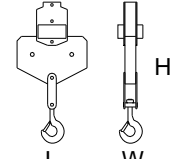
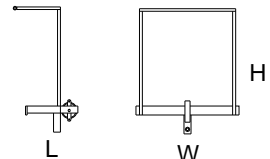

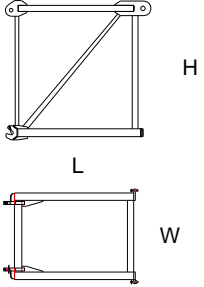
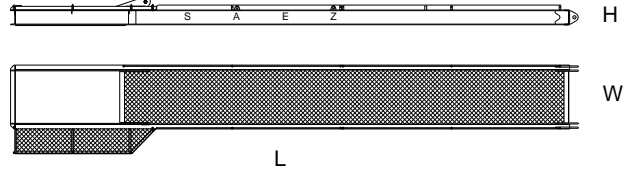
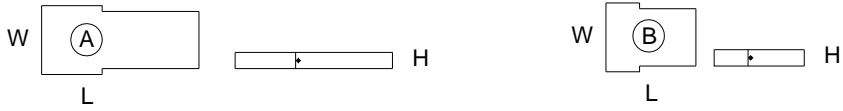

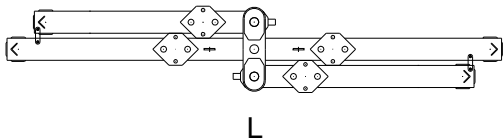
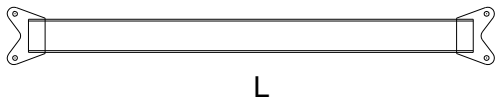
11,90 1.5 2,30 6200

		L(m)	W(m)	H(m)	Peso(Kg)	
<p>Elemento intermedio de pluma / Intermediate jib section / Ausleger-Zwischenstück Elément intern. de fleche / Spezzione di braccio</p>		2	5.30	1,5	2,25	1600
		3	5.3	1,5	2.25	1500
		4	6.35	1,5	2.25	1350
		5	11.6	1,5	1,80	1500
		6	5,30	1,5	1,80	736
		7	5,30	1,5	1,8	630
		8	5,30	1,5	1,45	545
		9	5,15	1,5	1,45	484
		10	5,15	1,5	1,45	396
		11	5,15	1,5	1,45	360
		12	5,15	1,5	1,45	280
<p>Gancho, Carro y Puntera / Hook, Trolley and jib head / Lasthaken - Laufkatze-Cabeça de Lança Crochet - Chariot-Pointe de fleche / Gancio - Carrello e Punta freccia</p>		1,20	1,65	0,80	290	
		0,80	0,15	1,50	330	
		0,80	1,60	1,40	108	
						

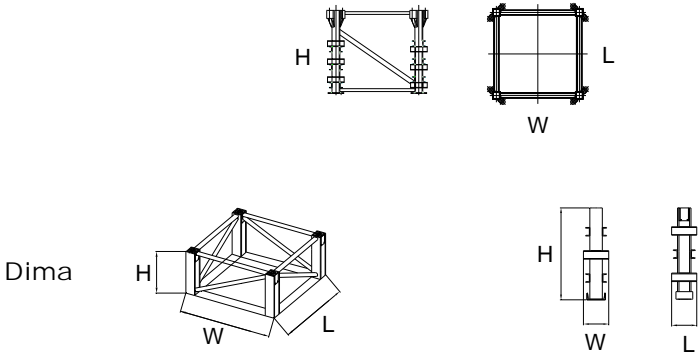
	L(m)	W(m)	H(m)	Peso(Kg)
<p>Colin / Counter-jib / Gegenausleger / Contre-fleche / Controbraccio</p> 	2.5	1.63	2.35	1500
<p>Contrapluma / Counter-jib / Gegenausleger / Contre-fleche / Controbraccio</p> 	11.94	1.80	0.60	2575
<p>Bloque de contrapeso / Counterweight blocks / Gegengewichtsblöcke / Bloc de contrepoids / Blocco di contrappeso</p> 	3.20	1.25	0.29	2500
	1.83	1.25	0.29	1500

	L(m)	W(m)	H(m)	Peso(Kg)
<p>Base Cruciforme 4,5 X4,5 / Crossbase 4,5 X 4,5 / Fundamentkreuz 4,5 X 4,5 / Châsis 4,5 X 4,5 / Carro base 4,5 X 4,5</p> 	6,70	1,10	1,20	5750
<p>Vigas auxil. de base / Half base beams / Halbträger für fundamentkreuz / Semipoutre de châsis de base / Travi di congiunzi di congiunzione</p> 	4,40	0,30	0,55	220

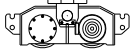
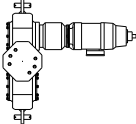
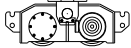
		L(m)	W(m)	H(m)	Peso(Kg)	
Bloque lastre de base / Base ballast block / Grundballastblöcke / Bloc de lest de base Blocco di zavorra alla base <div style="text-align: center;">  </div>		4,40	0,30	1,20	3800	
Bloque apoyo de base / Base support block / Grundballastblöcke / Bloc de appui de base Blocco di appoggio alla base <div style="text-align: center;">  </div>		3,75	0,5	1,2	5400	
Elemento de empotre / Foundation anchor / Fundamentanker / Élément de scellement El annegare <div style="text-align: center;">  </div>		S60/8	1,85	1,85	1,6	956
		S60/R16	1,85	1,85	1,6	1108
		S70/8	2,27	2,27	1,6	1122
		S70R/16	2,27	2,27	1,6	1274
		S75R16/20	0.35	0.35	1.6	1200
		S75R16/22	0.5	0.5	2	2840
		S75R16/26	0.5	0.5	2.4	3160
		S75R24/26	0.5	0.5	2.4	3400
		Dima	2.31	2.34	0.8	1650

	L(m)	W(m)	H(m)	Peso(Kg)
<p>Niveladores / Levellers / Spindel pyramide / Niveleurs / Piedi regolabile</p> <p>n.° 4</p> <div style="display: flex; align-items: center; justify-content: center;"> <div style="text-align: center;">  <p>H</p> </div> <div style="text-align: center; margin: 0 20px;">  <p>L</p> </div> <div style="text-align: center;"> <p>(x4)</p> </div> </div> <p style="text-align: center;">W</p>	1,20	1,20	0,90	250
<p>Traslacion / Travelling bogies / Kranfahren / Traslacion / Traslazione</p> <div style="display: flex; align-items: center; justify-content: center; margin-bottom: 10px;"> <div style="text-align: center;">  <p>H</p> </div> <div style="text-align: center; margin: 0 20px;">  <p>L</p> </div> <div style="text-align: center;"> <p>(x2)</p> </div> </div> <p style="text-align: center;">W</p> <div style="display: flex; align-items: center; justify-content: center;"> <div style="text-align: center;">  <p>H</p> </div> <div style="text-align: center; margin: 0 20px;">  <p>L</p> </div> <div style="text-align: center;"> <p>(x2)</p> </div> </div> <p style="text-align: center;">W</p>	1,15	1,25	0,45	505
	1,15	0,25	0,45	450

	L(m)	W(m)	H(m)	Peso(Kg)
Elemento de torre TL16 / Tower section TL16 / Turmstück TL16 / Element de mât TL16 / Elemento di torre TL16	K 11,8	1,85	1,85	4600
	K 5,9	1,85	1,85	2472
	K 3	1,85	1,85	1425
	L 11,8	1,85	1,85	5520
	O 11,8	2,27	2,27	5044
	O 5,9	2,27	2,27	2640
	O 3	2,27	2,27	1545
	P 11,8	2,27	2,27	5700
	N 5,9			3500
	X 6	2,27	2,29	4000
	T 6	2,27	2,29	4300
	U 6	2,31	2,34	5910
	Z 6	2,61	2,34	5980

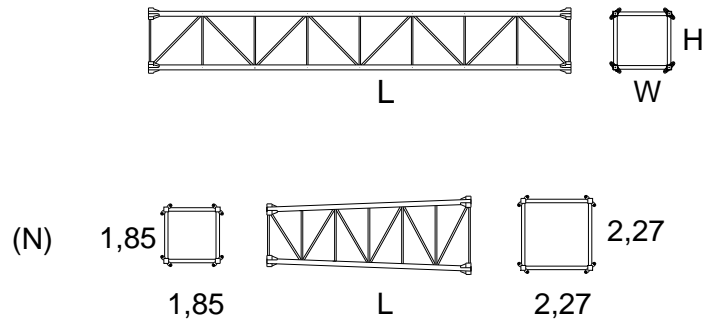

Unidad de rotacion / Complete slewing unit / Drehbühne / Orientation / Rotazione

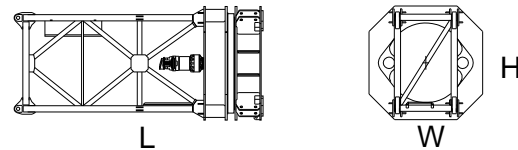

4,40 2,00 2,00 7200

Cabina y soporte / Cabin and support / Kabine und wartungs / Cabine et support / Cabina e supporto

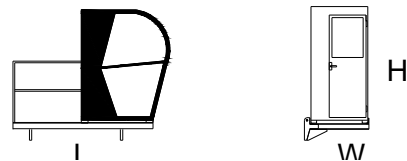

3,00 1,15 2,35 558

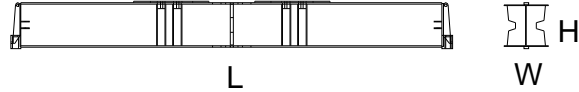
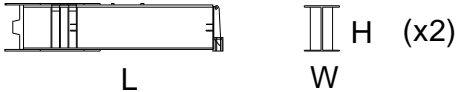
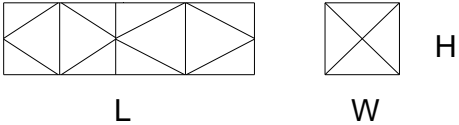
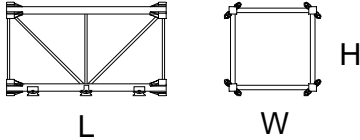
	L(m)	W(m)	H(m)	Peso(Kg)
<p>Viga principal base 6x6 / Main base beam / Hauptträger für fundamentkreuz Poutre de châssis de base / Trave principale della base</p> 	8,65	0,78	0,92	4300
<p>Semiviga secundaria base 6x6 / Half base beam / Halbträger für fundamentkreuz Semipoutre de châssis de base / Semitrave secundaria della base</p> 	4,27	0,68	0,97	2025
<p>Caja de trepado-S17 / Climbing cage / Hydraulikbühne Cage de montage / Gabbia di montaggio</p> 	7,35	2,1	2,1	6400
<p>Tramo trepador / Tower element / Turmstück Element de mature / Elemento di torre monolitico</p> 	3	1,85	1,85	1425

ESPECIFICACIONES SUJETAS A MODIFICACIONES SIN PREVIO AVISO.

Specifications subject to modification without notice.

Obiges kann ohne berstaendigung geaendert werden.

Specifications susceptibles de modification sans avis préalable.

Specifiche suscettibili di variazioni senza preavviso.

DECLINAMOS TODA RESPONSABILIDAD DERIVADA DE LA INFORMACION PROPORCIONADA.

This information is supplied without liability.

Sämtliche Angaben erfolgen ohne Gewähr.

Ces renseignements sont sans garantie.

Le indicazioni contenute si intendono salvo errori ed omissioni.